

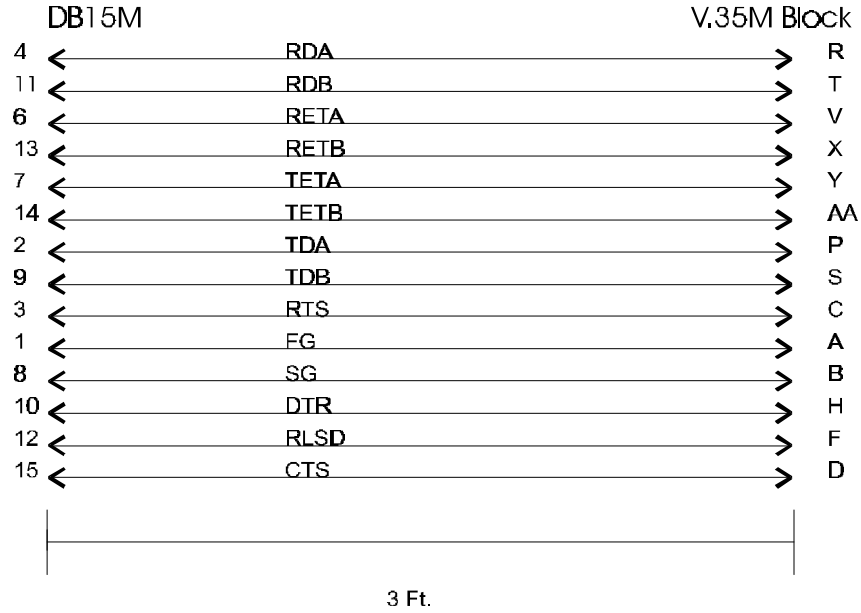

## Appendix A — Cable Diagrams

Cable C1300. DB15M To V.35 Block



Cable C1400 — DB15M To V.35 DB25M

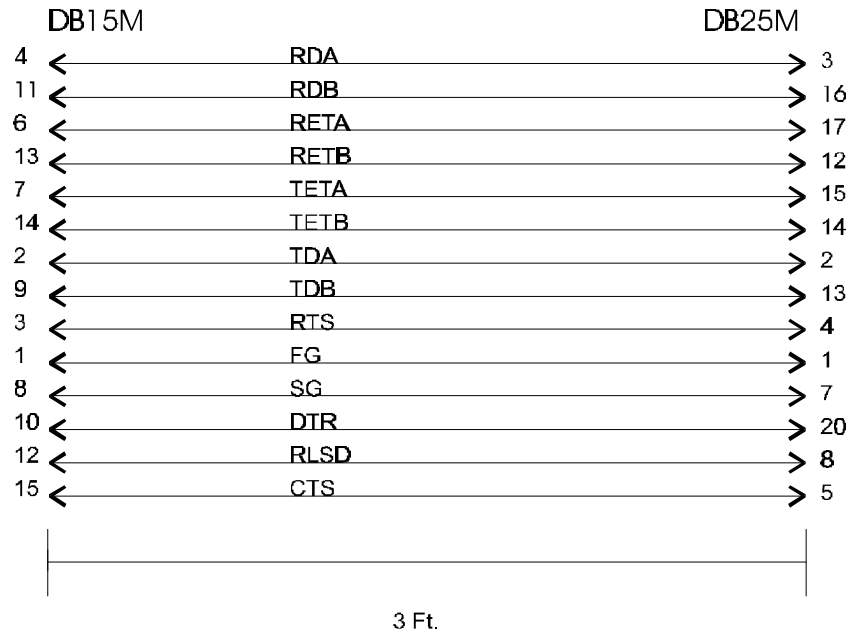

**Cable C1500 — Prima 110 And 120 AES Adapter**  
DB9M

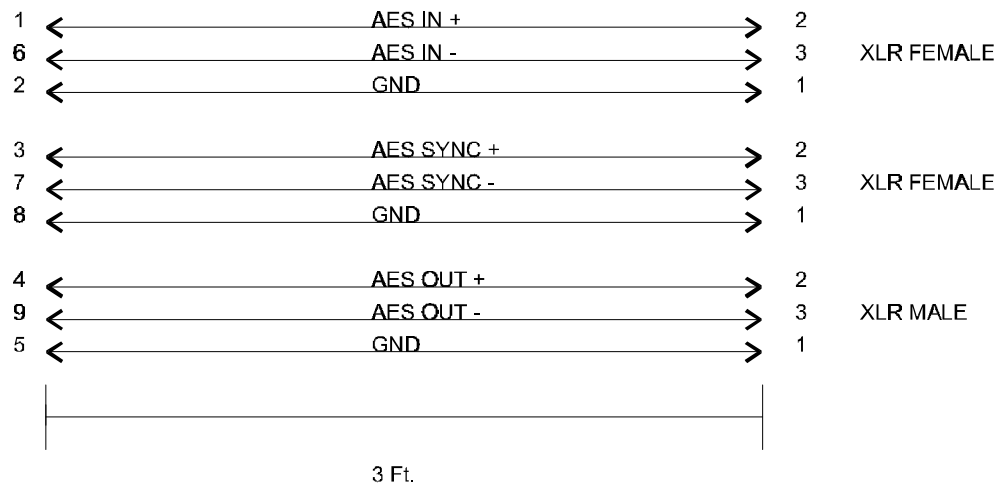

**Cable C1600 — SMPTE Time Code Cable**  
DB25M

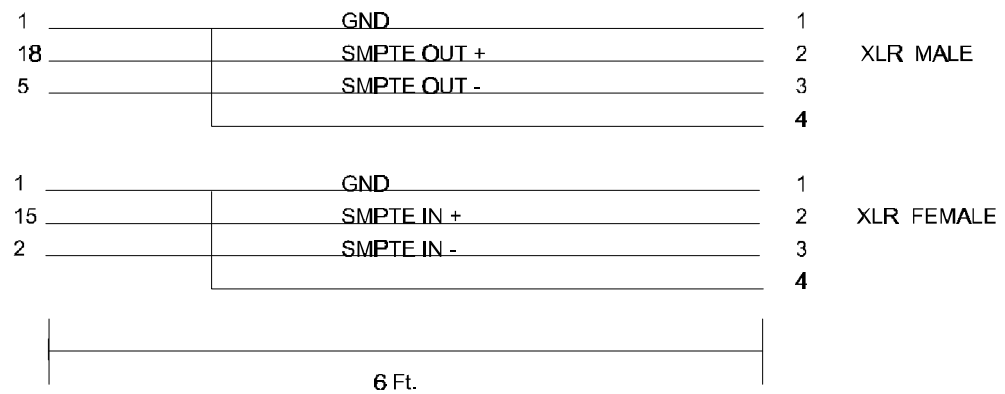

**Cable C1700 — Ancillary Data And RS232 Cable**  
DB9F DB9F

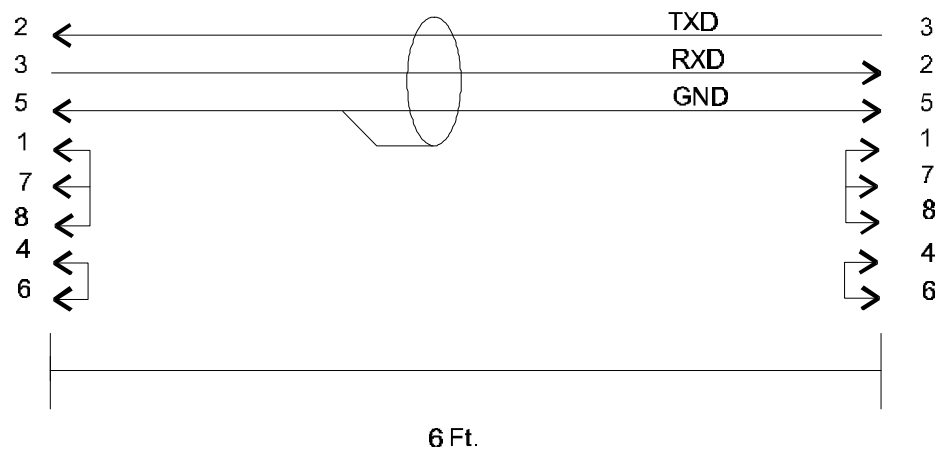

**Cable C1800 — Rear Panel RS232 Remote Control Cable**

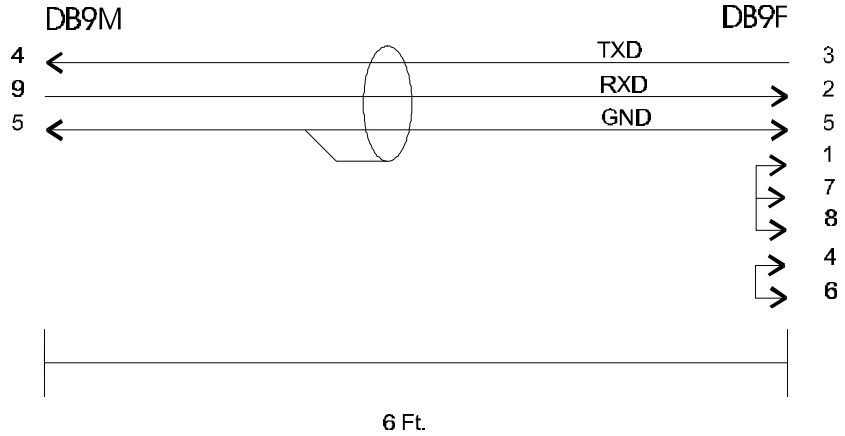

**Cable C1900 — Rear Panel RS485 Remote Control Cable**

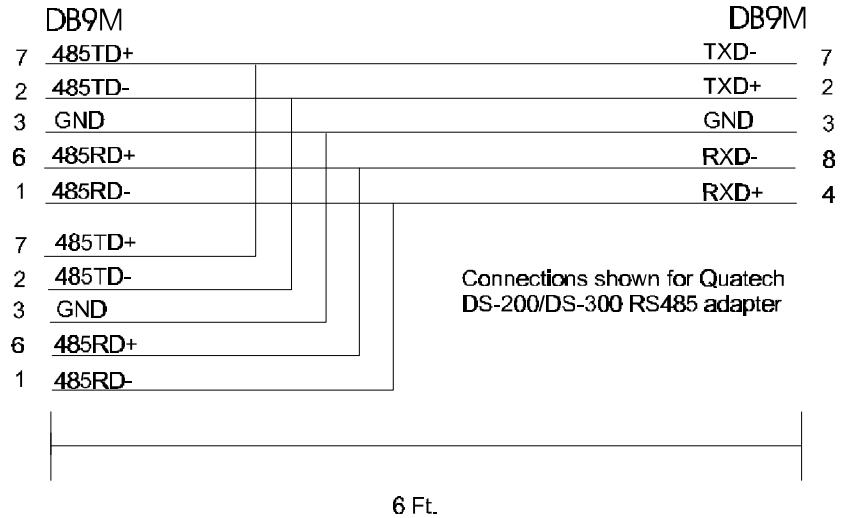

**Cable C2000 — Front Panel RS212 Remote Control Cable**

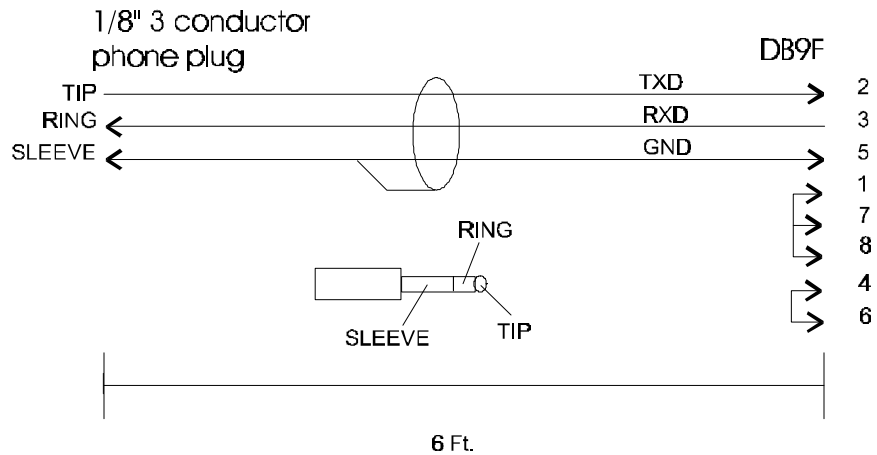

## Appendix B — Rear Panel Connectors

### ***CDQPrima*** 1xx Series

#### Audio Input

Connector: Female XLR

1	Ground
2	+
3	-

#### Audio Output

Connector: Male XLR

1	Ground
2	+
3	-

#### AES/EBU

Connector: AMP 747158-8 (Female DB9)

##### Digital Audio Input

1	IN+
6	IN-
2	Ground

##### Digital Audio Output

4	OUT +
9	OUT -
5	Ground

##### Digital Audio Sync Input

3	SYNC IN +
7	SYNC IN -
8	Ground

#### RS232/RS485 Remote Control

Connector: AMP 747150-8 (Female DB9)

##### RS232 (rear panel remote control port)

4	RD (input)
9	TD (output)
5	Ground

##### RS485

1	RD- (Input)
6	RD+ (Input)
2	TD- (Output)
7	TD+ (Output)
3	Ground

#### Ancillary Data

Connector: AMP 747871-8 (Male DB9)

1	DCD	Input
2	RXD	Input
3	TXD	Output
4	DTR	Output
5	Ground	
6	DSR	Input
7	RTS	Output
8	CTS	Input
9	no connection	

## Alarm Relay

Connector: AMP 747871-8 (Male DB9)

1	Common 1
2	no connection
3	Normal 2 (power on and no summary alarm (RLS) )
4	Common 2
5	Alarm 1 (power off or summary alarm (RLS) )
6	no connection
7	Alarm 2 (power off or summary alarm (RLS) )
8	no connection
9	Normal 1 (power on and no summary alarm (RLS) )

## Sync Data - Opto/Relay

Connector: AMP 745967-8 (Female DB25)

### Sync Data

1	STXD
14	SRXD
2	STXC
15	SRXC
3	Ground

### Opto Input

5	OPA+
17	OPA-
6	OPB+
18	OPB-
7	OPC+
19	OPC-
8	OPD+
20	OPD-

### Relay Output

9	OUTA1
21	OUTA2
10	OUTB1
22	OUTB2
11	OUTC1
23	OUTC2
12	OUTD1
24	OUTD2
POWER	
13	Fused (1ASB) +5 VDC
25	Ground

## ***CDQPrima*** 2xx Series, ***Prima LT*** Series

### Audio Input

Connector: Female XLR

1	Ground
2	+
3	-

### Audio Output

Connector: Male XLR

1	Ground
2	+
3	-

## AES/EBU

Digital Audio Input	Digital AudioOutput	Digital Audio Sync Input
Connector: Female XLR	Connector: Male XLR	Connector: Female XLR
1 Ground	1 Ground -	1 Ground
2 IN+	2 OUT +	2 SYNC IN +
3 IN -	3 OUT -	3 SYNC IN -

## RS232/RS485 Remote Control

Connector: AMP 747150-8 (Female DB9)

RS232	RS485
4 RD (input)	1 RD- (Input)
9 TD (output)	6 RD+ (Input)
5 Ground	2 TD- (Output)
	7 TD+ (Output)
	3 Ground

## Ancillary Data

Connector: AMP 747871-8 (Male DB9)

1 DCD	Input
2 RXD	Input
3 TXD	Output
4 DTR	Output
5 Ground	
6 DSR	Input
7 RTS	Output
8 CTS	Input
9 no	

## Alarm Relay

Connector: AMP 747871-8 (Male DB9)

1 Common 1
2 no connection
3 Normal 2 (power on and no summary)
4 Common 2
5 Alarm 1 (power off or summary)
6 no connection
7 Alarm 2 (power off or summary)
8 no connection
9 Normal 1 (power on and no summary)

## Opto Inputs

Connector AMP 745968-8 (Male DB25)

2	OPA+	19	OPE-
15	OPA-	7	OPF+
3	OPB+	20	OPF-
16	OPB-	8	OPG+
4	OPC+	21	OPG-
17	OPC-	9	OPH+
5	OPD+	22	OPH-
18	OPD-	11,12,23,24	Ground
6	OPE+	1,14	Fused (1ASB) +5

## Relay Outputs

Connector: AMP 745968-8 (Female DB25)

2	OUTA1	19	OUTE2
15	OUTA2	7	OUTF1
3	OUTB1	20	OUTF2
16	OUTB2	8	OUTG1
4	OUTC1	21	OUTG2
17	OUTC2	9	OUTH1
5	OUTD1	22	OUTH2
18	OUTD2	11,12,23,24	Ground
6	OUTE1	1,14	Fused (1ASB) +5

## RS232

Connector: AMP 747871-8 (Male DB9)

1	DCD	Input	6	DSR	Input
2	RXD	Input	7	RTS	Output
3	TXD	Output	8	CTS	Input
4	DTR	Output	9	no	
5	Ground				

## Front panel remote control

Connector: 1/8" stereo headphone

Ring	RD (input)
Tip	TD (output)
Sleeve	Ground

## RS485

1	RD- (Input)
6	RD+ (Input)

2 TD- (Output)  
 7 TD+ (Output)  
 3 Ground

SMPTE Time code

Connector AMP 747838-4 (Female DB25)

Input			Output		
15	+		18	+	
2	-		5	-	
1	Ground		1	Ground	

## DIF101, DIF102

### X.21

Connector: DB15F

1	fg	Frame ground
2	t(a)	Transmit data A (output)
3	c(a)	Control element A (output)
4	r(a)	Receive data A (input)
5	i(a)	Indicator element A (input)
6	s(a)	Timing element A (input)
7	b(a)	Byte timing A (input)
8	sg	Signal ground
9	t(b)	Transmit data B (output)
10	c(b)	Control element B (output)
11	r(b)	Receive data B (input)
12	i(b)	Indicator element B (input)
13	s(b)	Timing element B (input)
14	b(a)	Byte timing B (input)
15		N/C

### V.35

Connector: DB15F

1	fg	Frame ground
2	tda	Transmit data A (output)
3	rts	Request to send
4	rda	Receive data A (input)
5		N/C
6	reta	Receive timing A (input)
7	teta	Transmit timing A (output)
8	Sg	Signal ground
9	tdb	Transmit data B (output)
10	dtr	Data terminal ready
11	rdb	Receive data B (input)
12	rlsd	Receive line signal detect (carrier detect)
13	retb	Receive timing B (input)
14	tetb	Transmit timing B (output)
15	cts	Clear to send

## Appendix C — Factory Defaults

The factory default values are as follows:

CAA 1 YES		set auto answer on for line 1
CAA 2 YES		set auto answer on for line 2
CAA 3 YES		set auto answer on for line 3
CAA 4 YES		set auto answer on for line 4
CAA 5 YES		set auto answer on for line 5
CAA 6 YES		set auto answer on for line 6
CAC NO		set to no auto reconnect
CAN 2		set ancillary data port to configuration 2 (mux)
CBR 256		set loopback digital interface bit rate
CBZ NO		internal alarm buzzer inactive
CCV 7		set LCD contrast
CDC NO		don't display connect time
CDM		clear dialing parameters
CDR 9600		set decoder DSP ancillary data rate
CEA LN0	!OI0	set default link actions
CEA LN1	!OI1	
CEA LN2	!OI2	
CEA LN3	!OI3	
CEA LN4	!OI4	
CEA LN5	!OI5	
CEA LN6	!OI6	
CEA LN7	!OI7	
CEA LN8	CI1	SCUE1 button
CEA LN9	CI2	SCUE2 button
CEA LN10	BER	
CEA LN11	OOF	
CEA ESM	!EPL	
CEA DSM	!DPL # BER # OOF	
CEA RLS	EPL & DPL & !BER & !OOF	
CEA RL0	LN0	
CEA RL1	LN1	
CEA RL2	LN2	
CEA RL3	LN3	
CEA RL4	LN4	
CEA RL5	LN5	
CEA RL6	LN6	
CEA RL7	LN7	
CEA SC1	CI1	
CEA RC1	LN8	
CEA VA0		all Virtual Actions cleared

CEA VA1	
CEA VA2	
CEA VA3	
CFB 9600	set front panel remote control baud rate
CFE YES	set to echo front panel commands
CFM 4 Wires	set rear panel 485 port to 4 wires
CFP NO	set no front panel remote control protocol
CGH OLDPKI	set to old PKI framing in H.221 mode
CHK 1	clear all hot keys
CHK 2	
CHK 3	
CHK 4	
CHK 5	
CHK 6	
CHK 7	
CHK 8	
CHP E	
CID 0	set to RS485 ID 0
CIF 1 NONE	set to no digital interface
CIF 2 NONE	set to no digital interface
CIF 3 NONE	set to no digital interface
CIF 4 NONE	set to no digital interface
CIF 5 NONE	set to no digital interface
CIF 6 NONE	set to no digital interface
CLB 1 NORM	set no digital loopback on DIF 1
CLB 2 NORM	set no digital loopback on DIF 2
CLB 3 NORM	set no digital loopback on DIF 3
CLB 4 NORM	set no digital loopback on DIF 4
CLB 5 NORM	set no digital loopback on DIF 5
CLB 6 NORM	set no digital loopback on DIF 6
CLI STATUS 10	set status led intensity
CLI ENCODER 10	set encoder led intensity
CLI DECODER 10	set decoder led intensity
CLL A ON	set all speed dialing
CMA 2400	set mux ancillary data 2400 baud
COB 1200	set OTHER RS232 port to 1200 baud
CON 3	
COS	set other RS232 term chars to NULL
COT NONE	set OTHER RS232 port usage
CPC NO	no protocol for remote communications
CRB 9600	set remote control baud rate
CRD 1	set number of TA redial attempts to 1
CRE YES	set to echo rear panel commands

CRI 232	RS232 for remote communication
CRM 4WIRES	set RS485 remote control port to 4 wire
CSL LB	system loopback
CSP RS232	set sync anc data interface to RS232
CTC NONE	no connection to any TA
CTI NONE	no time code display
CTM 0 0	turn off timer 0
CTM 1 0	turn off timer 1
CTM 2 0	turn off timer 2
CTM 3 0	turn off timer 3
CTO 15	set TA dialing time-out in seconds
CTT OFF	no time code hardware
CVA 0	set virtual action 0 to empty
CVA 1	set virtual action 1 to empty
CVA 2	set virtual action 2 to empty
CVA 3	set virtual action 3 to empty
CVU LEVEL	set level meter to level (vu mode)
DAF CCS	set decoder ancillary data format
DAL MPEGL2	set to MPEG I layer 2
DCO ISOCCS	set decoder decoding mode to ISO and CCS
DCS NORM	set decoder output to no copy or swap
DDO 48	set to 48 kHz digital output
DES NOTREQ	set decoder AES sync timing not required
DHV 75	set decoder headphone volume
DIN NO	set decoder to operate together with encoder
DMD NORM	set decoder maintenance diagnostic mode to normal
DMU NONE	set decoder mute to none
DSB NONE	set no decoder synchronous ancillary data
DSC LOWHIGH	set decoder synchronous ancillary rate clock edge
DSP NO	set to no decoder scale factor
DTI NORMAUTO	set decoder timing to normal
EAF CCS	set encoder ancillary data format
EAI A	set input to analog
EAL MPEG2	set to MPEG layer 2
EAM JS	set to joint stereo
EMM Off	set to no mono mix
ESR 48	set encoder sampling rate to 48
EBR 256	set encoder to 256K bit rate
ECR NO	set no copyright bit
ECS NORM	set to no channel swap
EEP NO	set no emphasis bit
EHV 75	set encoder headphone volume
ELI L1	set encoder line format to 1 line, line 1

ELU 1	set to link messages every .1 sec
EOR NO	set no original bit
EPI OFF	set no privacy bit off
EPR YES	set protection bit
EPY 0 1	set psychoacoustic parameter type
EPY 1 2	set psychoacoustic parameter type
EPY 2 1	set psychoacoustic parameter type
EPY 3 2	set psychoacoustic parameter type
EPY 4 1	set psychoacoustic parameter type
EPY 5 3	set psychoacoustic parameter type
EPY 6 1	set psychoacoustic parameter type
EPY 7 1	set psychoacoustic parameter type
EPY 8 1	set psychoacoustic parameter type
EPY 9 3	set psychoacoustic parameter type
EPY 10 4	set psychoacoustic parameter type
EPY 11 3	set psychoacoustic parameter type
EPY 12 4	set psychoacoustic parameter type
EPY 13 0	set psychoacoustic parameter type
EPY 14 1	set psychoacoustic parameter type
EPY 15 3	set psychoacoustic parameter type
EPY 16 4	set psychoacoustic parameter type
EPY 17 3	set psychoacoustic parameter type
EPY 18 4	set psychoacoustic parameter type
EPY 19 4	set psychoacoustic parameter type
EPY 20 3	set psychoacoustic parameter type
EPY 21 3	set psychoacoustic parameter type
EPY 22 1	set psychoacoustic parameter type
EPY 23 1	set psychoacoustic parameter type
EPY 24 1	set psychoacoustic parameter type
EPY 25 1	set psychoacoustic parameter type
EPY 26 4	set psychoacoustic parameter type
EPY 27 3	set psychoacoustic parameter type
EPY 28 4	set psychoacoustic parameter type
EPY 29 4	set psychoacoustic parameter type
EPY 30 1	set psychoacoustic parameter type
EPY 31 1	set psychoacoustic parameter type
ESB NONE	set no encoder synchronous ancillary data
ESC LOWHIGH	set encoder synchronous ancillary data clock edge
ESD OFF	set encoder sine wave detector off
ESP NO	set to no encoder scale factor protection
ESW CI0 OFF	set simulated switch 0 open
ESW CI1 OFF	set simulated switch 1 open
ESW CI2 OFF	set simulated switch 2 open

ESW CI3 OFF	set simulated switch 3 open
ESW CI4 OFF	set simulated switch 4 open
ESW CI5 OFF	set simulated switch 5 open
ESW CI6 OFF	set simulated switch 6 open
ESW CI7 OFF	set simulated switch 7 open
ETI NORM	set encoder timing to normal
EXD 50	set extended input debounce time
EXI OFF	set extended input port usage
EXM 1111111111111111	set extended input mask
MBD 1	set BER count down counter
MBE NO	disallow remote boot
MBL 1	set BER limit to 1
MBP 10	set BER maximum count at 10
MBR	clear the BER counter
MBU 1	set BER count up counter
MBX ON	set keypad clicker on
MCP NONE	set to no connect port
MET DISABLED	disable hardware tests
MLK KEYPAD NO	set no command lockout from keypad
MLK INBAND NO	set no command lockout from inband
MLK FRONT NO	set no command lockout from front panel
MLK REAR NO	set no command lockout from rear panel
MLK DIF NO	set no command lockout from digital
MLK VA NO	set no command lockout from virtual
MOD 1	set OOF down counter
MOL 10	set OOF limit to 10
MOP 20	set OOF count maximum
MOU 2	set OOF up counter
MQL EL -60	set encoder left quiet threshold level
MQL ER -60	set encoder right quiet threshold level
MQL DL -60	set decoder left quiet threshold level
MQL DR -60	set decoder right quiet threshold level
MQL E -60	set encoder stereo quiet threshold level
MQL D -60	set decoder stereo quiet threshold level
MQT EL 10	set encoder left quiet threshold time
MQT ER 10	set encoder right quiet threshold time
MQT DL 10	set decoder left quiet threshold time
MQT DR 10	set decoder right quiet threshold time
MQT E 10	set encoder stereo quiet threshold time
MQT D 10	set decoder stereo quiet threshold time
MRS RP	set rear panel remote control source to rear
MTM NONE	set to no test measurements
MWP NONE	set to no watch port

## Appendix D — Opto-Isolator And Relay I/O

### Opto Inputs

The monitor and control feature of the **CDQPrima** allows the input of various voltage sources. These inputs can be TTL level signals (0.8 to 2.4 volts) or optical isolated inputs (3 to 30 volts). The input circuitry for both types of signals is shown in Fig D-1. A consequence of the circuitry is that with no signal applied, the output of the circuit is a 1. With a signal applied, the output is a 0. Thus, an inversion occurs on the input. This means that when the CEV Oix command is issued to sense the inputs, they will be inverted. This can be easily accounted for in the Prima Logic Language (PLL) by use of the ! operator.

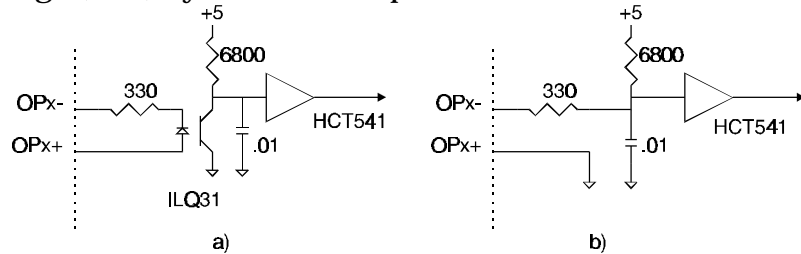

Figure D-1 Monitor input circuitry—a) optically isolated input, b) TTL input

### Relay Outputs

The control feature of the **CDQPrima** allows external devices to be controlled by either contact closures generated by the **CDQPrima** or open collector outputs. The Circuitry for this control is shown in Fig D-2.

Setting Rlx (in the Prima Logic Language) to a 1 closes the relay in the case of relay output but it causes the output voltage to go low on the open collector output. The sense of either of these outputs can be changed by statements in the Prima Logic Language.

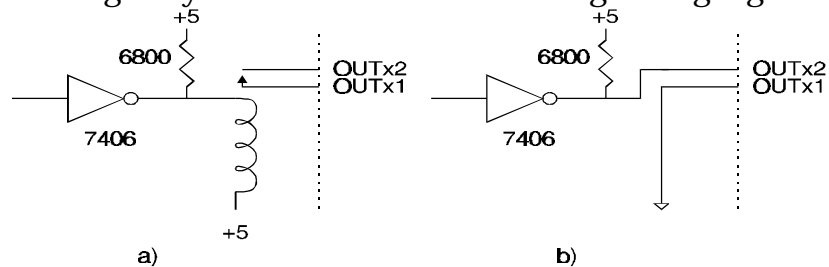
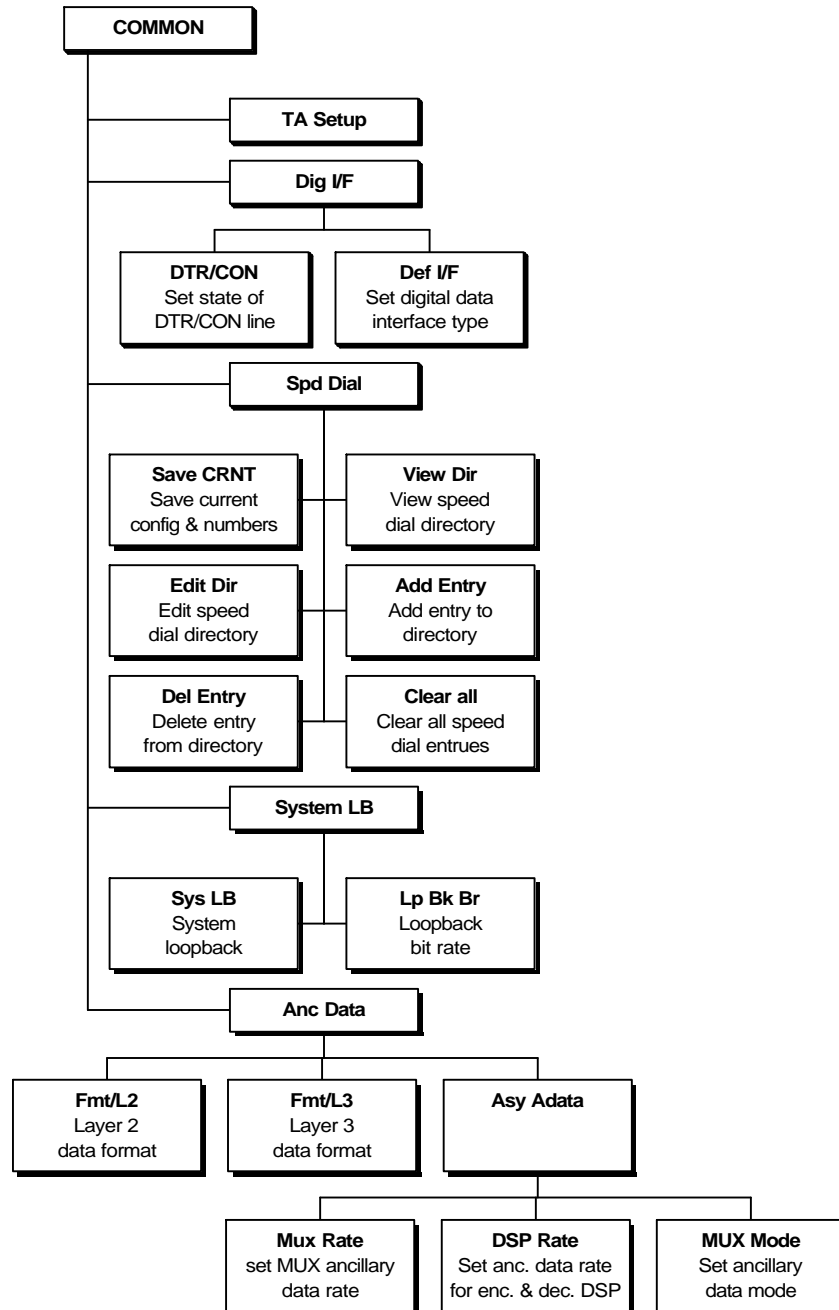

Figure D-2 Control outputs—a) relay output, b) open collector output

To change from relay output to common collector output, jumper pins 3 to 12 and pins 5 to 10 on the appropriate relay chip.

## Appendix E — *CDQPrima* LCD Menu Tree

### COMMON COMMANDS 1



COMMON COMMANDS 2

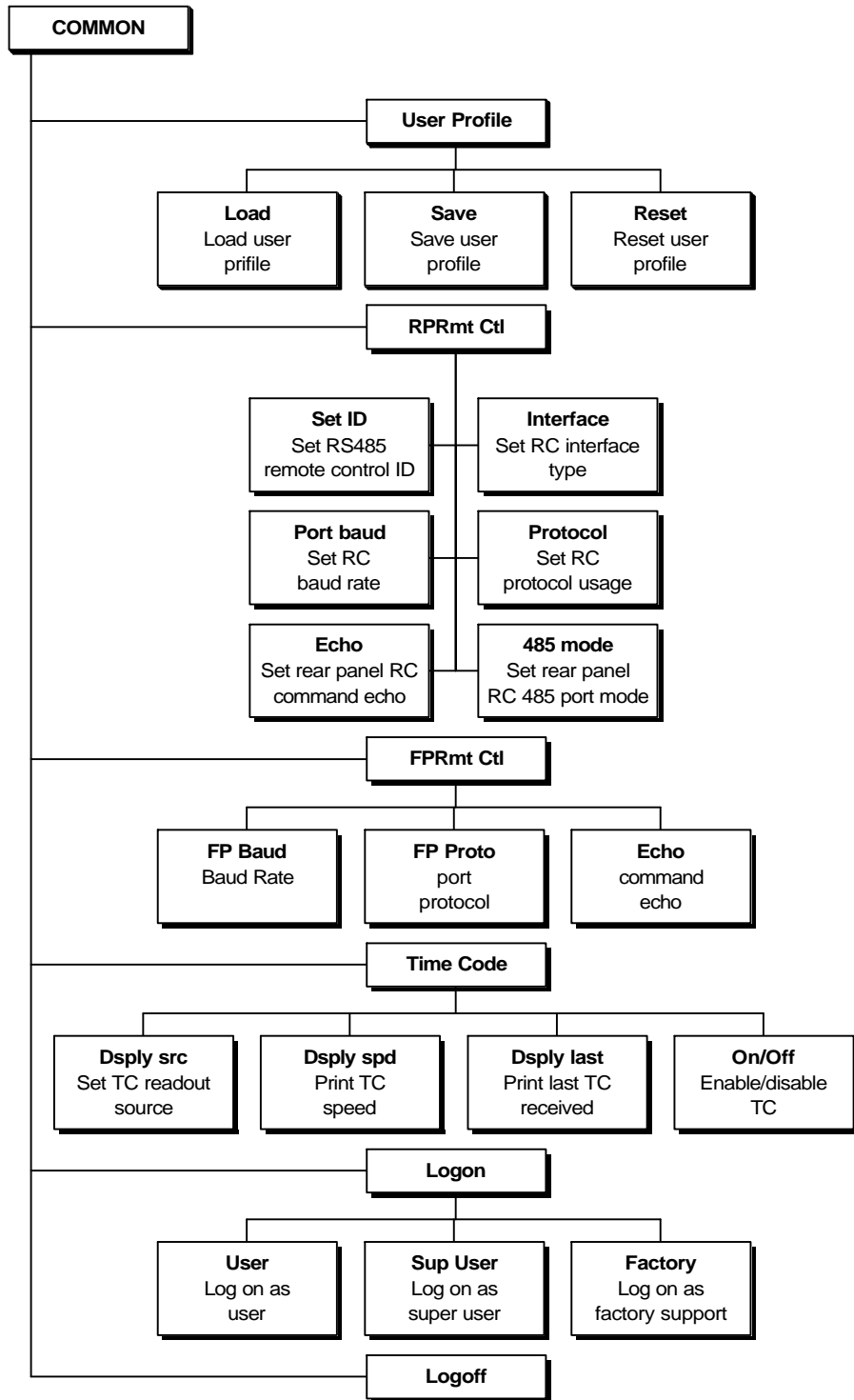

COMMON COMMANDS 3

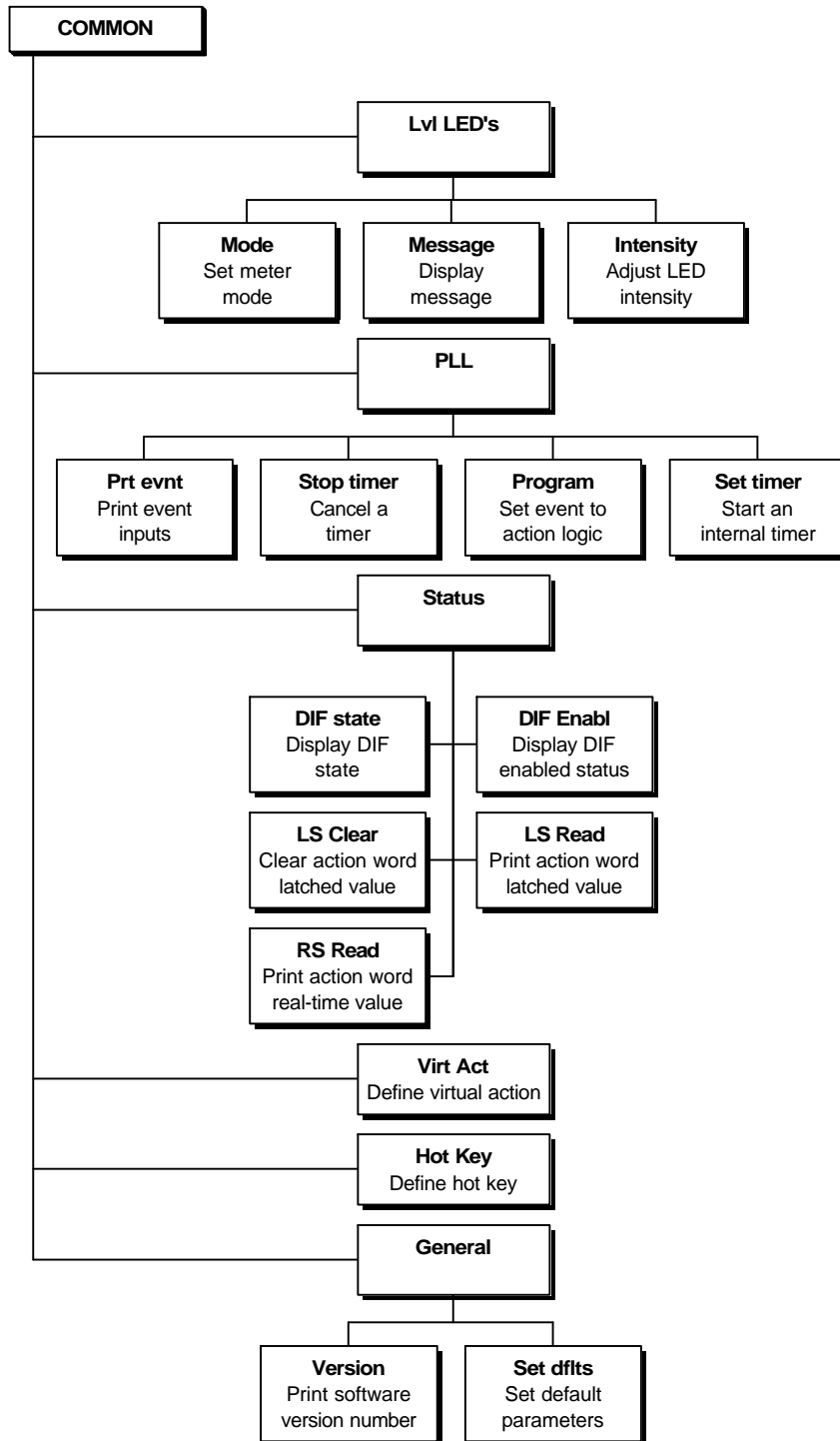

### COMMON COMMANDS 4

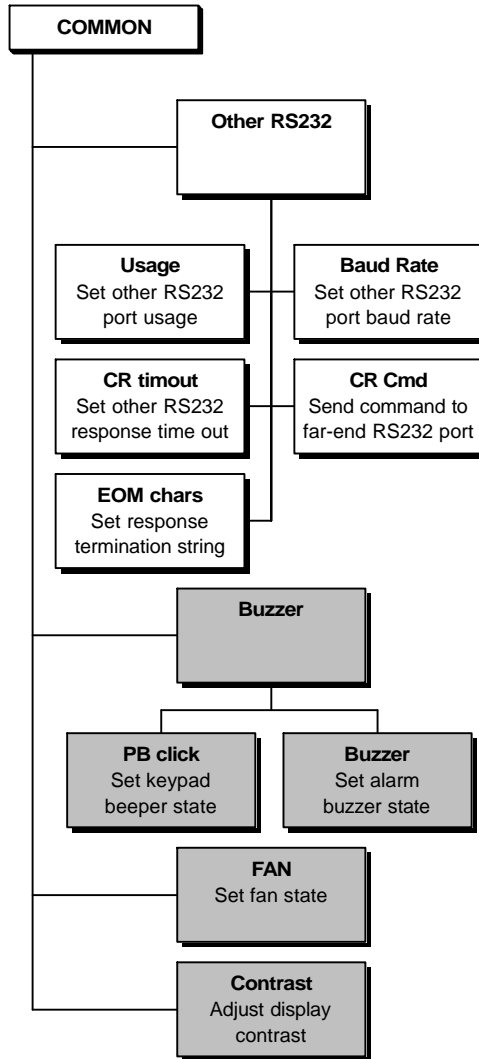

## ENCODER MENU TREE

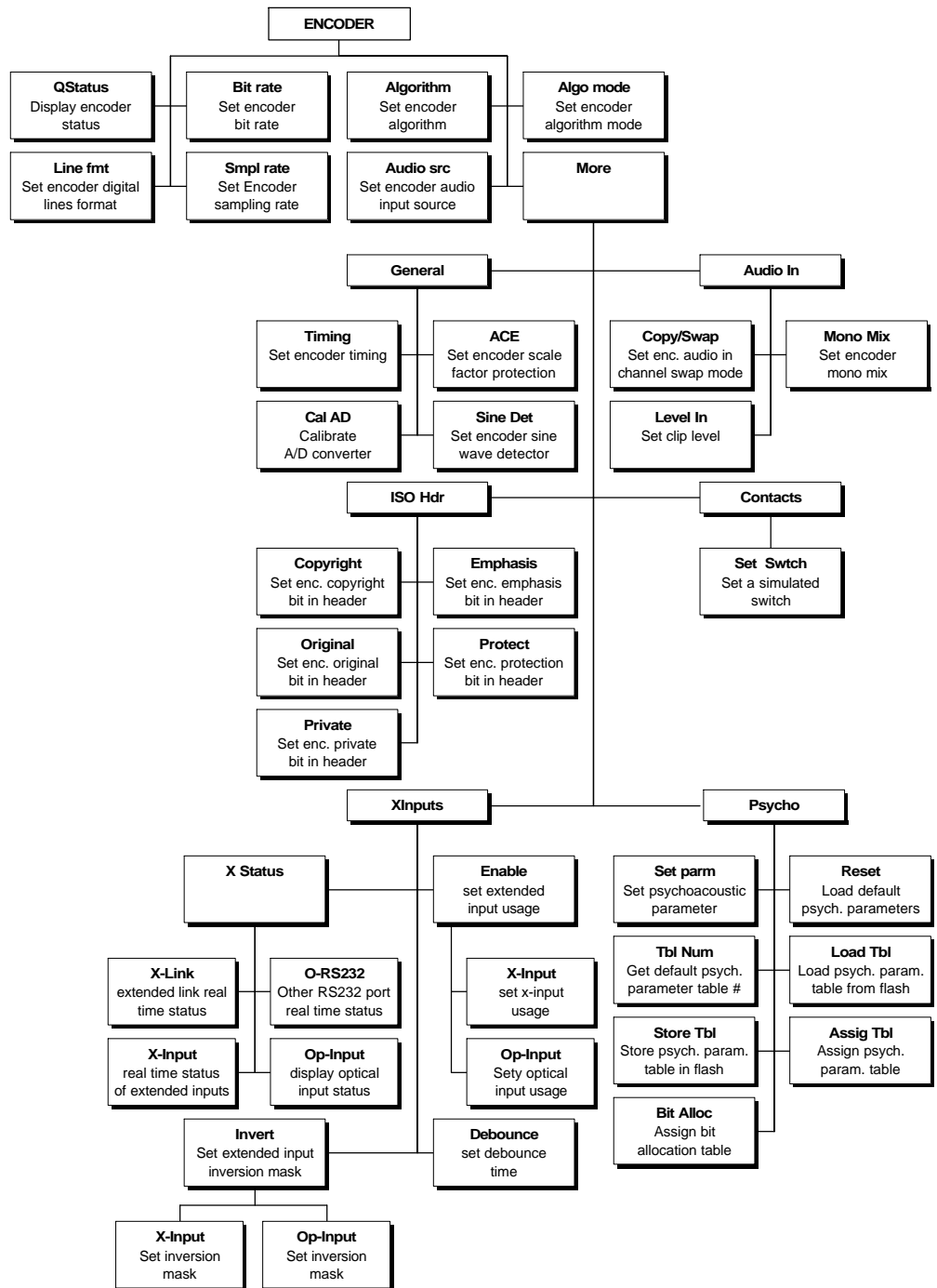

## DECODER COMMAND TREE

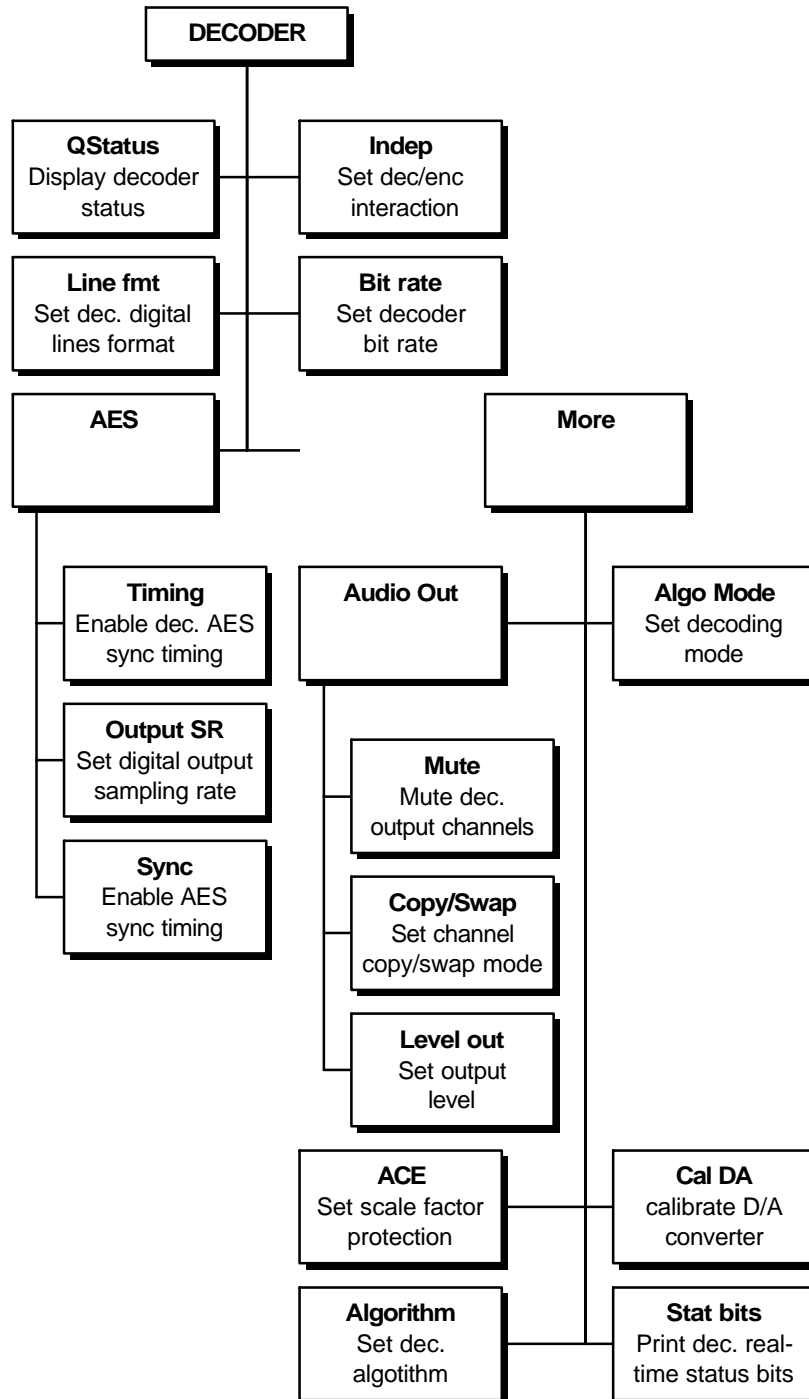

## MAINTENANCE MENU TREE - PAGE 1

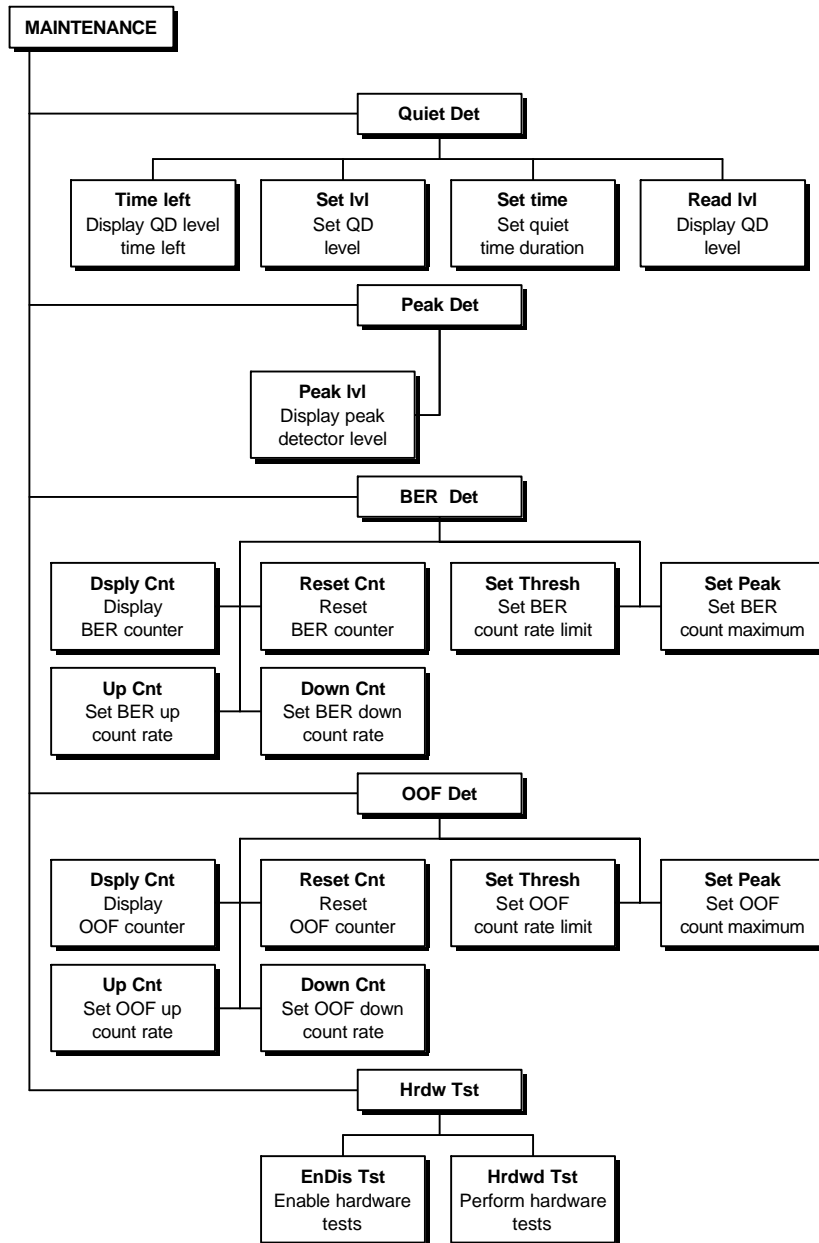

## MAINTENANCE MENU TREE - PAGE 2

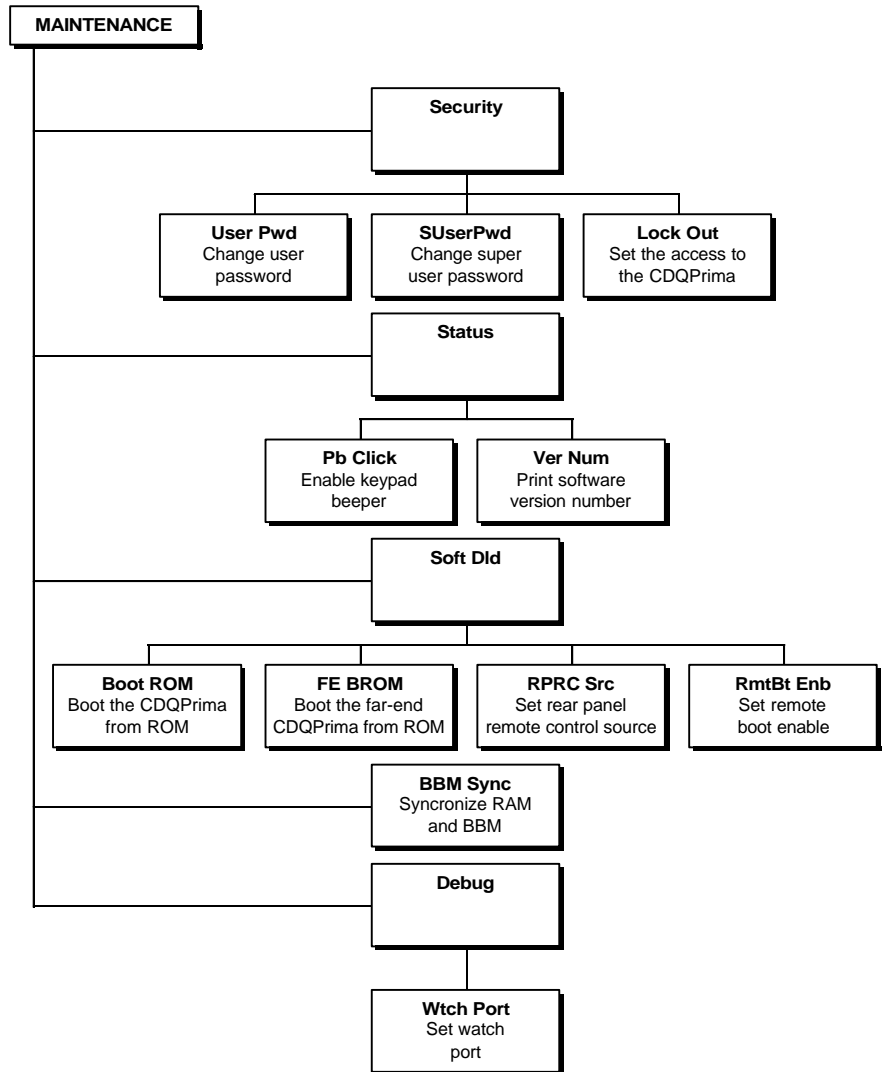

## Appendix F — ISDN Ordering And Provisioning

### North American ISDN Ordering Contacts

Ameritech	800-TEAMDATA
AT&T	800-222-7956
Bell Atlantic	800-570-ISDN
Bellcore	800-992-ISDN
BellSouth	800-428-ISDN
Cincinnati Bell	800-566-DATA
GTE	800-888-8799
MCI	800-MCI-ISDN
Nevada Bell	702-333-4811
Pacific Bell	800-4PB-ISDN
Rochester Telephone	716-777-1234
SNET	203-553-2369
Sprint	913-624-4162
Stentor Canada	800-578-ISDN
Southwestern Bell	800-992-ISDN
US West	800-246-5226 or 303-896-8301
Wiltel	918-588-5069

### North American ISDN Provisioning

In an effort to make ISDN ordering and provisioning as easy as possible, we recommend faxing the following five pages to your ISDN service provider. If provisioned as shown on these pages, your ISDN circuit will work with your **CDQPrima**, regardless of terminal adapter used. If given a choice between AT&T Custom or National ISDN, we recommend National ISDN. Also note that **when ordering ISDN service, you must ask for long distance service and specify a carrier.** Unlike regular telephone service, long distance is not automatically provided.

**FAX-PAGE 1****AT&T 5ESS Custom**

Request from the telephone company an ISDN line in a “Point To Point” configuration with 2B1Q line code. Your ISDN line must be configured to allow circuit switched data on both B-channels and signaling on the D-channel. Request that the telephone company program your ISDN line with the following attributes:

- Maximum terminals set to 1 (this tells the switch that there is 1 terminal active on this line.)
- Maximum B-channels set to 2; Actual User settings (this tells the switch that you are an actual user and may use both B-channels simultaneously.)
- Circuit switched data set to 2; circuit switched data channel set to any (this tells the switch that you may use both B-channels simultaneously. The “Any” tells the switch that either B-channel can be used for data.)
- Terminal type is Type A - Basic Terminal (this tells the switch you are a basic ISDN terminal.)
- Display set to Yes (this tells the switch that you have display capabilities.)
- Call appearance quantity set to 1 (this tells the switch that you want 1 appearance of your primary telephone number.)
- Call appearance preference set to Idle (this tells the switch that your software will make a positive choice of which call appearance it will use to initiate a call.)

The Telephone Company will also need to know any additional voice features that you require on your ISDN lines. Examples of these features are Caller ID and Call Forwarding. PLEASE REMEMBER TO SPECIFY A LONG DISTANCE CARRIER.

FAX-PAGE 2
------------

**AT&T 5ESS - National ISDN 1**

Request from the telephone company a National ISDN 1 ISDN line in a “multipoint” configuration with 2B1Q line code. The optional “multipoint” configuration will allow you to have a separate telephone number for each B-channel; however, it will physically be only one ISDN line. The Telephone Company should supply you with a different telephone number and SPID (Service Profile Identification) for each B-channel in a multipoint arrangement. Your ISDN line must be configured to allow circuit switched data on both B-channels and signaling on the D-channel. Request that the Telephone Company program your ISDN line with the following attributes:

- Maximum terminals set to 2 (this tells the switch that there are 2 terminals active on this line.)
- Maximum B-channels set to 2; Actual User settings (this tells the switch that you are an actual user and may use both B-channels simultaneously.)
- Circuit switched data set to 2; circuit switched data channel set to any (this tells the switch that you may use both B-channels simultaneously. The “Any” tells the switch that either B-channel can be used for data.)
- Terminal type is Type A - Basic Terminal (this tells the switch you are a basic ISDN terminal.)
- Display set to Yes (this tells the switch that you have display capabilities.)
- Circuit switched data limit set to 2 (this tells the switch that you may receive 2 data calls.)
- Call appearance preference set to Idle (this tells the switch that your software will make a positive choice of which call appearance it will use to initiate a call.)

The Telephone Company will also need to know any additional voice features that you require on your ISDN lines. Examples of these features are Caller ID and Call Forwarding. PLEASE REMEMBER TO SPECIFY A LONG DISTANCE CARRIER.

**FAX-PAGE 3**

AT&T 5ESS — Custom

- 2B1Q line code
- 2B&D line - Point To Point
  - B1 - circuit switched voice/data
  - B2 - circuit switched voice/data
  - D - signaling only
  - set MTERM to 1
  - set MAXB CHNL to 2; ACT USR to Y
  - set CSD to 2; CSD CHL to ANY
  - set TERMTYP to TYPE-A; DISPLAY to Y
  - set CA QTY to 1
  - set CA PREF to I
- list any additional data features required
- specify long distance carrier

AT&T 5ESS — National ISDN

- 2B1Q line code
- 2B&D line - Standard
  - B1 - circuit switched voice/data
  - B2 - circuit switched voice/data
  - D - signaling only
  - set MTERM to 2
  - set CHNL to 2; ACT USR to Y
  - set CSD to 2; CSD CHL to ANY
  - set TERMTYP to TYPE-A; DISPLAY to Y
  - set CSD limit to 2
  - set CA PREF to I
- Optional - multipoint; different DN for each B-channel, but same OE (office equipment.)
- list any additional data features required
- specify long distance carrier

FAX-PAGE 4

## Northern Telecomm DMS-100 BC-35 National ISDN 1

Request from the telephone company a National ISDN 1 ISDN line with 2B1Q line code. Your ISDN line must be configured to allow circuit switched data on both B-channels and signaling on the D-channel. The telephone company should supply you with a separate telephone number and SPID (Service Profile Identification) for each B-channel; however, it will physically be only one ISDN line. Request that the Telephone Company program your ISDN line with the following attributes:

B1 and B2 should be set as follows:

- Set the circuit switch option to Yes; set the barrier restriction option to no packet mode data (NOPMD) only (this tells the switch that you require circuit switch ability on your B-channel, The bearer restriction on your line means that you are not allowed packet data on your B-channel.)
- Set protocol to function version 2; (PVC2) (this tells the switch that your CPE software is using National ISDN 1 protocol.)
- Set the service profile identification (SPID) suffix to 1 (this tells the switch that the digit following your telephone number will be 1. The SPID format is *area code + 7 digit number + 1 + 00*.)
- Set the Terminal Endpoint Identifier (TEI) to Dynamic (this tells the switch that you can accept any TEI value from 64 to 126.)
- Set Ring to Yes (this tells the switch to send an alerting message to your CPE when there is an incoming call.)
- Set the maximum keys to 10 (this tells the switch how much memory to allocate for features.)
- Set Key system (EKTS) option to No (this tells the switch that you are not a key system.)
- Place the lower layer compatibility option for data on the B-channels (this tells the switch that your CPE may utilize the lower layer compatibility information element for data on the B-channels.)
- Place calling subaddress option for data on the B-channels (this tells the switch that your CPE will send a subaddress.)
- Place called subaddress option for data on the B-channels (this tells the switch that your CPE can receive a subaddress.)

The Telephone Company will also need to know any additional data features that you require on your ISDN lines.

**FAX-PAGE 5**

Northern Telecomm DMS-100 BC-35 National ISDN 1

- 2B1Q line code
- 2B&D line
- B1 - set circuit switch to YES; set BEARER RESTRICTION to NOPMD (no packet)
  - functional version 2; (PVC 2)
  - set SPID-SUFFIX to 1
  - set TEI to DYNAMIC
  - set RING to YES
  - set MAXKEYS to 10
  - set EKTS to NO
  - set data option: PROVLLC CMDATA (lower layer compatibility)
  - set data option: PROVCGS CMDATA (calling subaddress)
  - set data option: PROVCDs CMDATA (called subaddress)
- B2 - set circuit switch to YES; set BEARER RESTRICTION to NOPMD (no packet)
  - functional version 2; (PVC 2)
  - set SPID-SUFFIX to 1
  - set TEI to DYNAMIC
  - set RING to YES
  - set MAXKEYS to 10
  - set EKTS to NO
  - set data option: PROVLLC CMDATA (lower layer compatibility)
  - set data option: PROVCGS CMDATA (calling subaddress)
  - set data option: PROVCDs CMDATA (called subaddress)

list any additional data features required for B1 and B2

## Appendix G — Specifications

All published specifications are typical and subject to change without notice.

### ANALOG AUDIO SPECIFICATIONS

Connector Type:	Gold plated Neutrik <sup>®</sup> 3-pin XLR
Input:	female
Output:	male
A/D & D/A converters:	24 bit sigma-delta
Sample frequencies:	16, 24, 32, or 48 kHz
Input impedance:	600 Ohms or >25 kOhm, balanced
Output impedance:	600 Ohms or < 60 Ohms, balanced
Clipping level:	+18 dBu, ± 1 dB, +12 and +15 dBu selectable
Insertion gain:	0 dB ±0.5 dB
System frequency response:	±0.3 dB, ref. @ 1 kHz. MUSICAM Layer II.
Fs = 16 KHz	20 to 7,500 Hz
FS = 24 KHz	20 to 11,250 Hz
System frequency response:	±0.15 dB, ref. @ 1 kHz. MUSICAM Layer II and Layer III.
Fs = 32 KHz	20 to 14,500 Hz
FS = 48 KHz	20 to 20,000 Hz
Total harmonic distortion:	<-80 dB @ 1 KHz
Signal-to-noise ratio:	>95 dB
Crosstalk:	<-85 dB
L/R phase difference:	<0.5°
Compression algorithms:	CCS MUSICAM <sup>®</sup> old CCS MUSICAM <sup>®</sup> new ISO/MPEG Layer II ISO/MPEG Layer III CCITT G.722 Storage for additional algorithms

Rev. 6

## DIGITAL AUDIO SPECIFICATIONS

Connector type, Models 110 and 120 and **Prima LT**:

DB9, female optional XLR adapter available

Connector type, Models 210, 220 and 23 and **Prima LT Plus**:

Input: Gold plated Neutrik<sup>®</sup> 3-pin XLR female  
 Output: Gold plated Neutrik<sup>®</sup> 3-pin XLR male  
 Sync input: Gold plated Neutrik<sup>®</sup> 3-pin XLR female  
 Interface type: AES/EBU or S/PDIF  
 Lock range:  $\pm 200$  ppm  
 Rate adaption: Automatic

## DATA INTERFACE SPECIFICATIONS

Network interface types: ISDN BRI (2B + D), RS422, V.35, X.21

Number of ISDN B channels supported: 1 to 6 in parallel

Bit rates: Layer II: 24, 32, 40, 48, 56, 64, 80, 96, 112, 128, 144, 160, 192, 224, 256, 320 or 384 kb/s.

Rev. 6

Layer III: 56, 64, 112, 128, 192, 256 or 320 kb/s  
 G.722 56 or 64 kb/s

Auxiliary data channel

Type of connector: DB9, female  
 Bit rate, direct mode: 300, 1,200, 2,400, 9,600, or 38,400 bps  
 Bit rate, Mux mode: 300, 1,200, 2,400, 9,600, or 19,200 bps  
 Mode: 8 data bits, 1 stop bit  
 Handshake: None required

Alarm interface

Type of connector: DB9, male  
 Functions: Summary alarm  
 Type: Form C contacts

## CONTROL INTERFACES

Level meters

Mode: Average, with peak hold  
 Range: 0 to -40 dB relative to full scale  
 Mode: L/R correlation  
 Range:  $\pm 1$   
 Mode: Stereo image  
 Range: +90 to -90 degrees

Scrolling text display	
Variable intensity	
Headphone output	
Modes:	Left encoder Right encoder Stereo encoder Left decoder Right decoder Stereo decoder
Level control:	front panel or remote control separate level set for encoder and decoder
Remote control, rear panel:	
Features controlled:	All except remote download
Electrical interfaces:	RS232-C or RS485
Connector:	DB9, male
Bit rates:	1,200, 2,400, 4,800, 9,600, or 38,400 bits/s
Mode:	8 data bits, 1 stop bit, no parity
Handshake:	None or XON/XOFF
Remote control, front panel:	
Features controlled:	All
Electrical interfaces:	RS232-C
Connector:	1/8" (0.32 cm) stereo jack
Bit rates:	1,200, 2,400, 4,800, 9,600, or 38,400 bits/s
Mode:	8 data bits, 1 stop bit, no parity
Handshake:	None or XON/XOFF
Digital Control Outputs, Models 110 & 120:	
Type:	Dry floating relay or open collector TTL
Number:	4
Connector:	DB25, female
Digital Control Outputs, Models 210, 220, and 230 and <b>Prima LT Plus</b> :	
Type:	Dry floating relay or open collector TTL
Number:	8
Connector:	DB25, female
Digital Monitor Inputs, Models 110 & 120:	
Type:	TTL or optically isolated
Number:	4
Connector:	DB25, female
Digital Monitor Inputs, Models 210, 220, and 230 and <b>Prima LT Plus</b> :	
Type:	TTL or optically isolated
Number:	8
Connector:	DB25, male
Cue Channel:	

Input: Front panel push button (Models 120, 220, & 230 only)  
 Output: Front panel LED (Models 120, 220, & 230 only)  
 SMPTE Time Code (Models 210, 220, 230 and **Prima LT Plus**):  
 Type: Input and output  
 LCD Display: Hours, minutes, seconds, frames, mode  
 Modes: 24, 25, 30, and drop frame, automatic detection  
 Connector: DB25, female, optional XLR adapter available

**GENERAL**

**Environmental Conditions:**

Storage temperature: -40 to +70° C (-40 to +158° F)  
 Operating temperature: 5 to +45° C (41 to +113° F)  
 Relative humidity: 20 to 80%, non-condensing  
 EMC: EN 50081-1, EN 50082-2

Power requirements: 90 to 250 VAC, 47 to 65 Hz. <60 Watts

**Dimensions, Models 110 and 120:**

Height: 1U (1.75", 4.45 cm)  
 Width: 19" (48.26 cm), rack mountable  
 Depth: 12.2" (30.99 cm)

**Dimensions, Models 210, 220, 230 and *Prima LT*:**

Height: 2U (3.5", 8.89 cm)  
 Width: 19" (48.26 cm), rack mountable  
 Depth: 12.2" (30.99 cm)

Net weight: Approx. 10 lbs. (4.5 Kg)

Shipping weight: Approx. 19.6 lbs. (8.9 Kg)

**DELAY MEASUREMENTS**

The following measurements are typical, ±20%

Bit Rate	Sample Rate	Algorithm	Line Fmt	M	JS	DM	S	M1
64	16	MPEGL2	L1	190	200	200	200	
64	24	MPEGL2	L1	140	135	135	135	
64	32	MPEGL2	L1	100	100	100	100	
64	48	MPEGL2	L1	70	70	70	75	
64	16	CCSO	L1	190	200	200	200	
64	24	CCSO	L1	135	135	135	125	
64	32	CCSO	L1	100	100	100	100	
64	48	CCSO	L1	70	-	-	-	
64	16	CCSN	L1	200	200	200	200	
64	24	CCSN	L1	140	135	135	135	
64	32	CCSN	L1	100	100	100	100	

64	48	CCSN	L1	70	-	-	-
----	----	------	----	----	---	---	---

64	16	G.722	L1	-	-	-	-	35
----	----	-------	----	---	---	---	---	----

The following measurements are for the CCS 2-Line mode. Low-delay single-line delay figures are typically ½ those shown here.

128	16	MPEGL2	CCSL12	-	-	-	-
128	24	MPEGL2	CCSL12	265	265	265	265
128	32	MPEGL2	CCSL12	230	230	230	230
128	48	MPEGL2	CCSL12	135	130	160	160
128	16	CCSO	CCSL12	-	-	-	-
128	24	CCSO	CCSL12	285	265	265	265
128	32	CCSO	CCSL12	230	230	230	230
128	48	CCSO	CCSL12	135	135	155	130
128	16	CCSN	CCSL12	-	-	-	-
128	24	CCSN	CCSL12	280	260	260	260
128	32	CCSN	CCSL12	195	230	230	230
128	48	CCSN	CCSL12	145	155	155	130

## Appendix H — One Year Limited Warranty

MUSICAM USA, formerly known as Corporate Computer Systems (CCS) warrants to the original purchaser that each of its hardware products and all components therein contained will be free from defects in materials and/or workmanship for one (1) year from the date of purchase. Any warranty hereunder is extended only to the original purchaser and is not assignable.

In the event of a malfunction or other indication of failure attributable directly to faulty workmanship and/or material, MUSICAM USA will, at its option, repair or replace said device or components, to whatever extent it shall deem necessary to restore said device to proper operating condition.

Before returning a device for repair, the customer must call MUSICAM USA at (732)739-5600 and obtain a return authorization number. This number should be included with the customer's mailing address and telephone number when the product is returned.

**Products must be returned to:**

**MUSICAM USA**

**670 North Beers St. Building #4**

**Holmdel, NJ 07733**

**U.S.A.**

**Attention: Warranty Repair**

During the first year after the date of purchase, all labor and materials will be provided without charge. There shall be no warranty for either parts or labor after the expiration of 1 year from the date of purchase.

Units must be returned postage pre-paid. It is recommended that the unit be insured and securely packed when shipped. Units returned which are out of warranty will be repaired or replaced (at the option of MUSICAM USA) and the customer will be charged for parts and labor at current rates.

Units will be returned to the customer after repair or replacement has been completed by carrier and method chosen by MUSICAM USA to any destination within the United States of America.

Should a customer desire some other specific form of conveyance, or be located beyond the US borders, then the customer must bear the cost of return shipment.

The customer shall be solely responsible for the failure of any MUSICAM USA hardware computer product, or component thereof, resulting from accident, abuse or misapplication of the product, and MUSICAM USA assumes no liability as a consequence of such events under the terms of this Warranty.

While every effort on the part of MUSICAM USA has been made to provide clear and accurate technical information on the application of its products, MUSICAM USA assumes no liability in any events which may arise from the use of said technical information.

**THERE ARE NO OTHER WARRANTIES MUSICAM USA DISCLAIMS ALL OTHER WARRANTIES, EITHER EXPRESS OR IMPLIED, INCLUDING BUT NOT LIMITED TO IMPLIED WARRANTIES OF MERCHANTABILITY AND FITNESS FOR A PARTICULAR PURPOSE. THIS LIMITED WARRANTY GIVES YOU SPECIFIC LEGAL RIGHTS. YOU MAY HAVE OTHERS, WHICH VARY FROM STATE TO STATE.**

**NO LIABILITY FOR CONSEQUENTIAL DAMAGES IN NO EVENT SHALL MUSICAM USA OR ANY OF ITS SUPPLIERS BE LIABLE FOR ANY DAMAGES WHATSOEVER (INCLUDING, WITHOUT LIMITATION, DAMAGES FOR LOSS OF BUSINESS PROFITS, BUSINESS INTERRUPTION, LOSS OF DATA COMMUNICATIONS, LOSS OF BUSINESS INFORMATION, OR OTHER PECUNIARY LOSS) ARISING OUT OF THE USE OF, OR INABILITY TO USE, THIS MUSICAM USA PRODUCT, EVEN IF MUSICAM USA HAS BEEN ADVISED OF THE POSSIBILITY OF SUCH DAMAGES. BECAUSE SOME STATES DO NOT ALLOW THE EXCLUSION OR LIMITATION OF LIABILITY FOR CONSEQUENTIAL OR INCIDENTAL DAMAGES, THE ABOVE LIMITATIONS MAY NOT APPLY TO YOU.**